

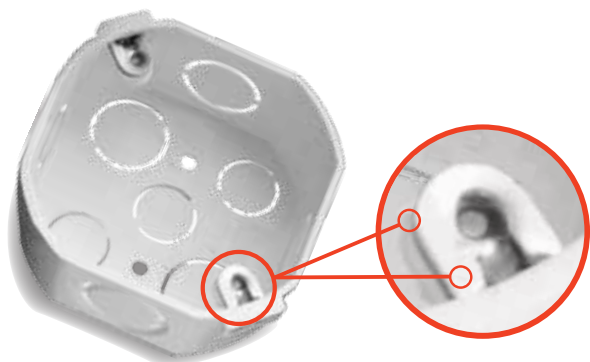



Beneficios



-  **Únicos con doble refuerzo**
-  **Fabricados con materia prima no reciclada**
-  **No propaga la llama**
-  **Resistente al impacto**
Gracias a aditivos especiales

Productos



Caja Rectangular

Dimensiones	Unidades por empaque
103 x 60 mm	24



Caja Octogonal

Dimensiones	Unidades por empaque
100 x 100 mm	12



Caja 4x4

Dimensiones	Unidades por empaque
105 x 105 mm	12



Caja 5x5

Dimensiones	Unidades por empaque
125 x 125 mm	6



Tapa Octogonal

Diámetro	Unidades por empaque
110 mm	24



Tapa 4 x 4

Dimensiones	Unidades por empaque
105 x 105 mm	24



Tapa 5 x 5

Dimensiones	Unidades por empaque
125 x 125 mm	24



Conectores

Medidas	Unidades por empaque
1/2"	25
3/4"	25

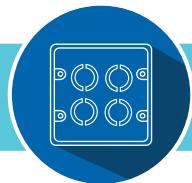

Conducción de cableado eléctrico

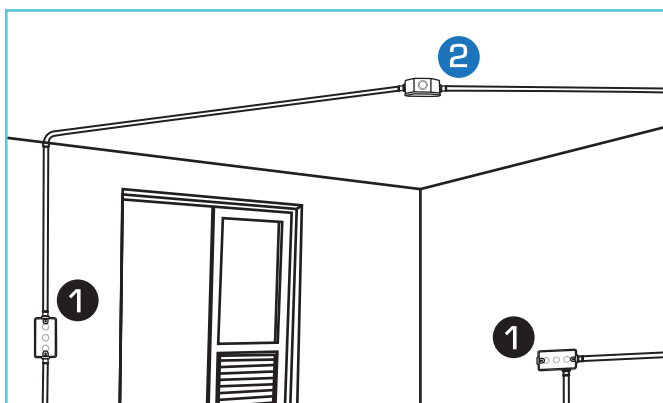

Caja Rectangular 1

Caja Octogonal 2

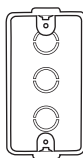

Usos comunes:

- Tomacorrientes
- Interruptores
- Pasa hilo
- Toma de teléfono
- Toma de TV

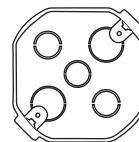

Usos comunes:

- Caja de conexión

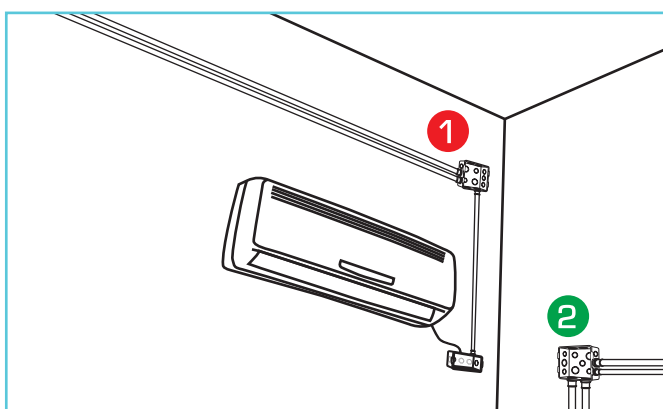

Caja 4x4 1

Caja 5x5 2

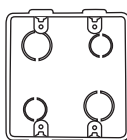

Usos comunes:

- Caja de conexión
- Instalado con bisel:
 - 1 o 2 tomacorrientes
 - 1 o 2 interruptores
 - 1 interruptor +
 - 1 toma corriente

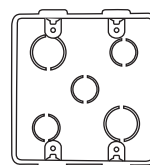

Usos comunes:

- Caja de conexión

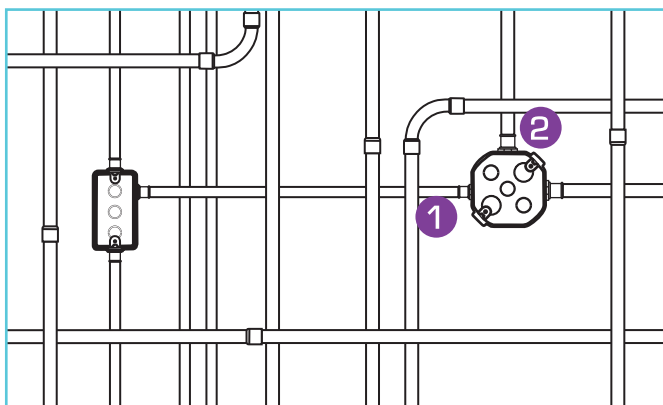

Conectores 1/2 1 Conector 3/4 2



Usos comunes:

- Conexiones de tuberías a las cajas de conexiones.

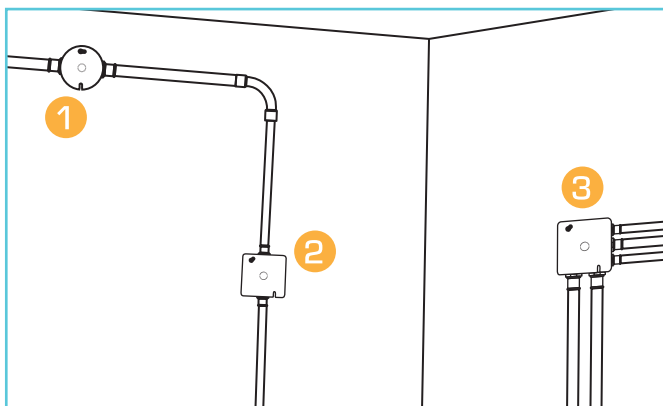

Tapa Octogonal 1 Tapa 4x4 2 Tapa 5x5 3

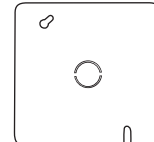
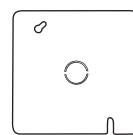
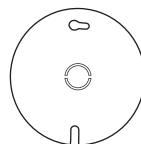

Usos comunes:

- Cierre de la caja que corresponda cuando es usada como conexión.